

8P (XP0002138)

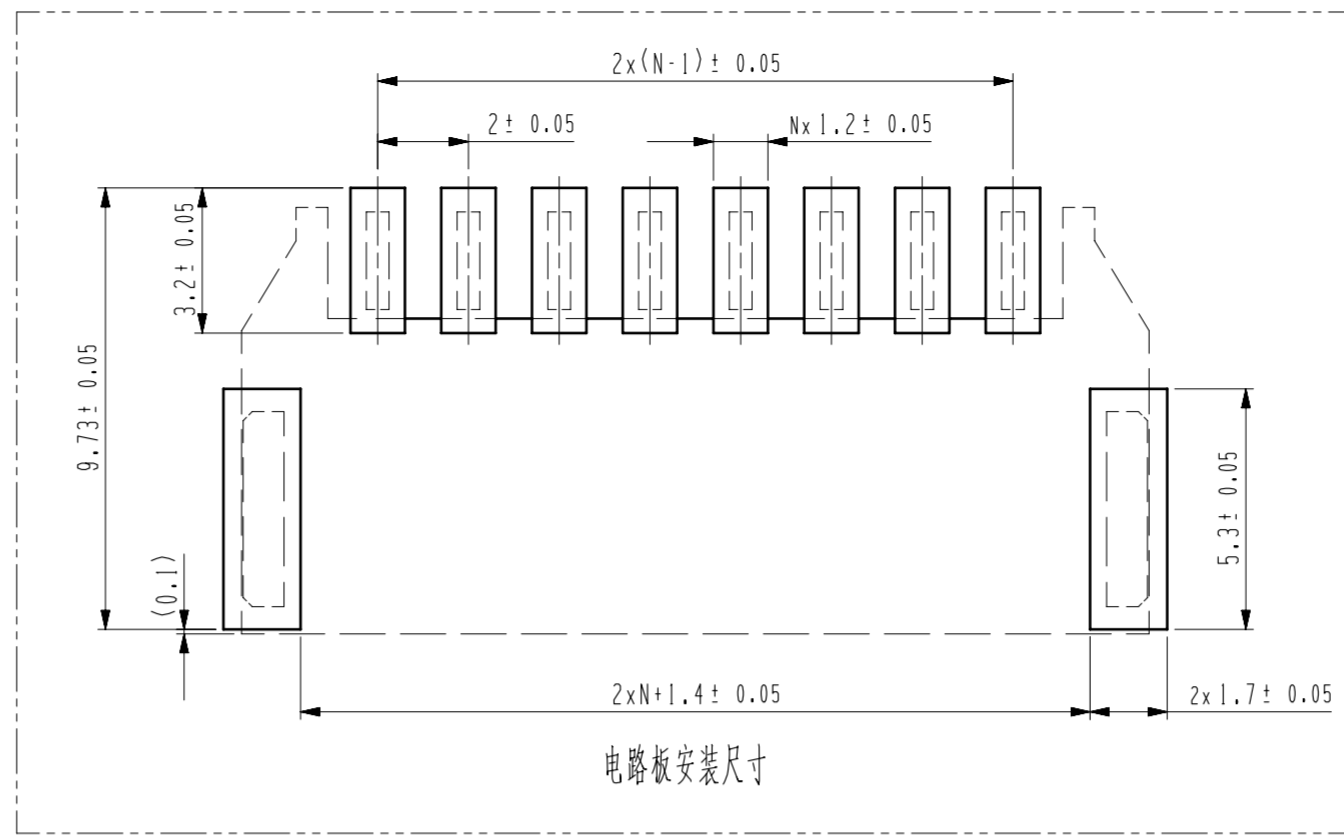

电路板安装尺寸

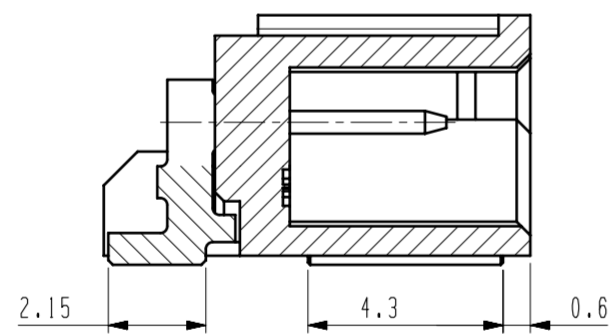
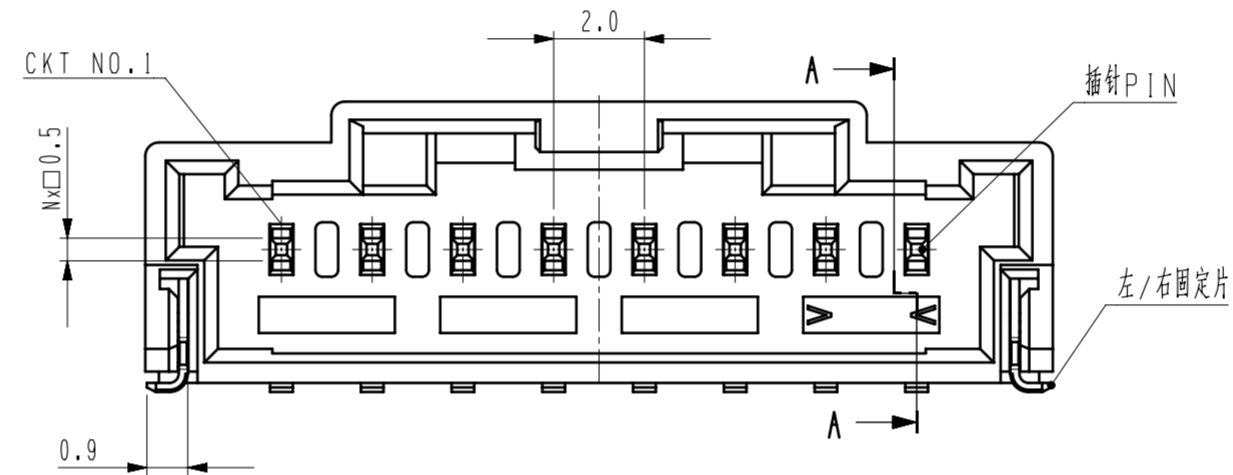
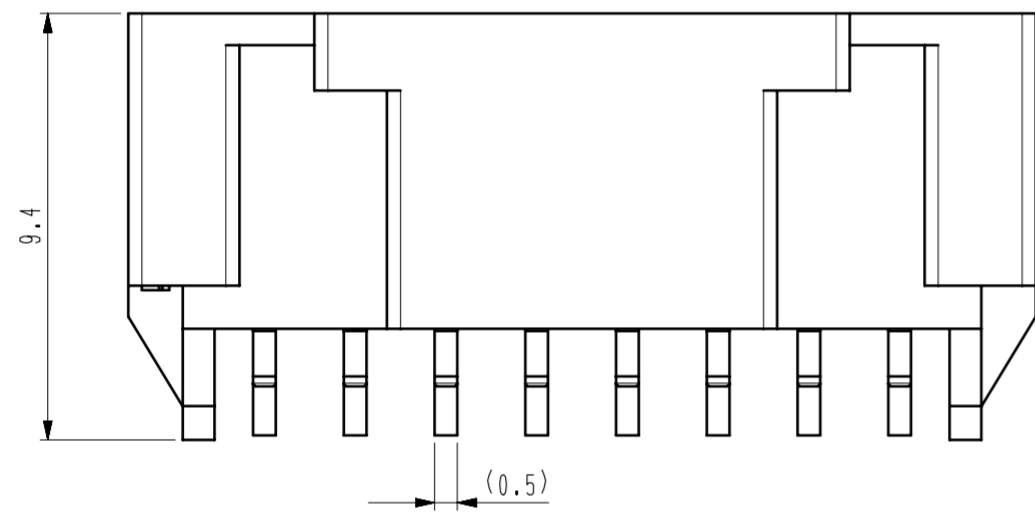

SECTION A-A
SCALE 6:1

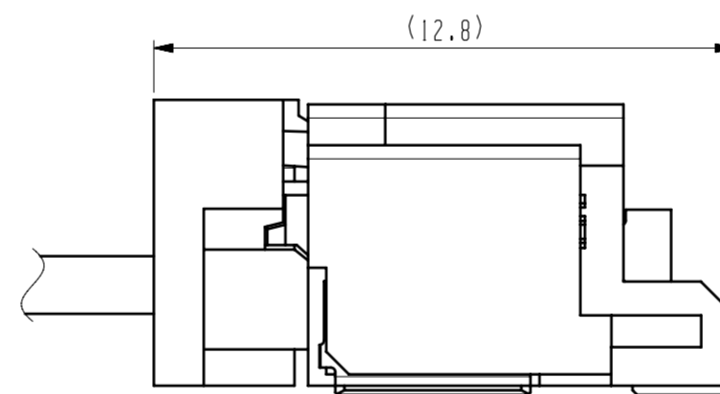

与护套配合后尺寸

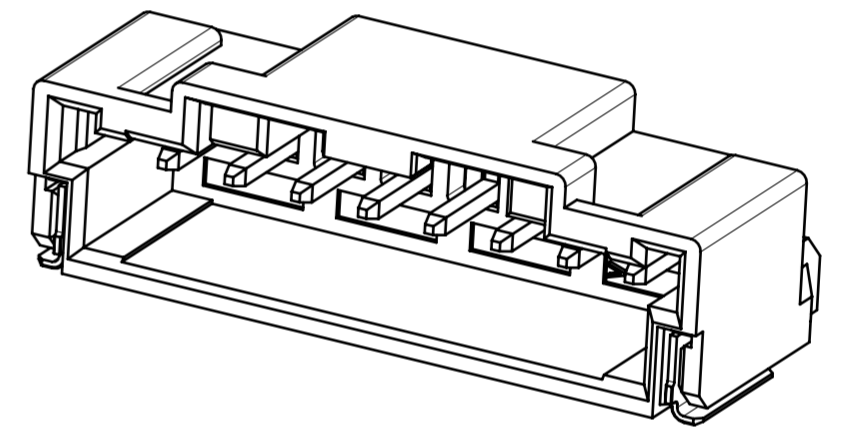
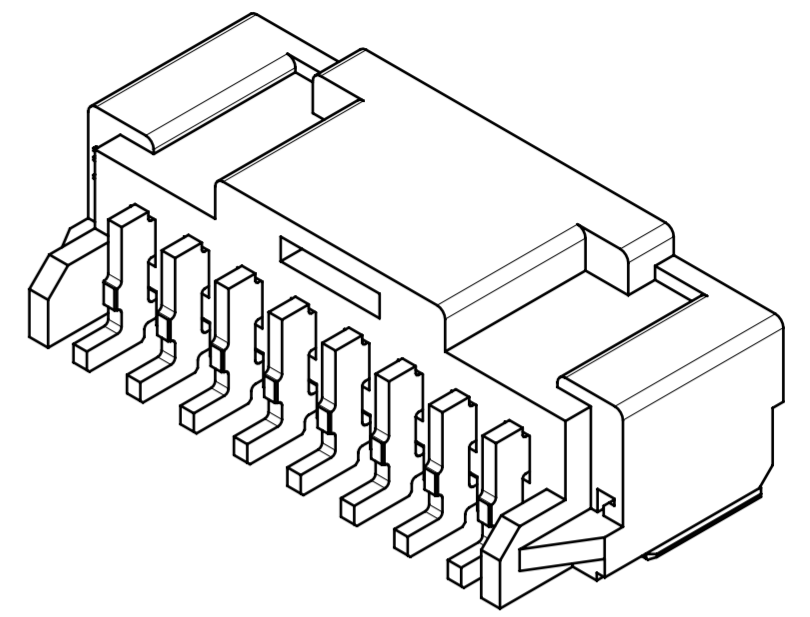

- 技术要求:
- 材料:
板端型壳: PA
插针PIN: Copper Alloy, 镀锡
左/右固定片: Copper Alloy, 镀锡
 - 适配零件号: 见表格
 - 颜色: 见表格
 - 适合回流焊, T: 255℃ Max
 - 符合ELV及RoHS标准
 - 焊接面平面度 0.1mm Max
 - 包装方式见左图, 包装数量: 700Pcs/卷盘
 - 未注公差见一般公差表

一般公差表	
≤10	±0.20
>10≤30	±0.25
>30	±0.30
角度	±3°

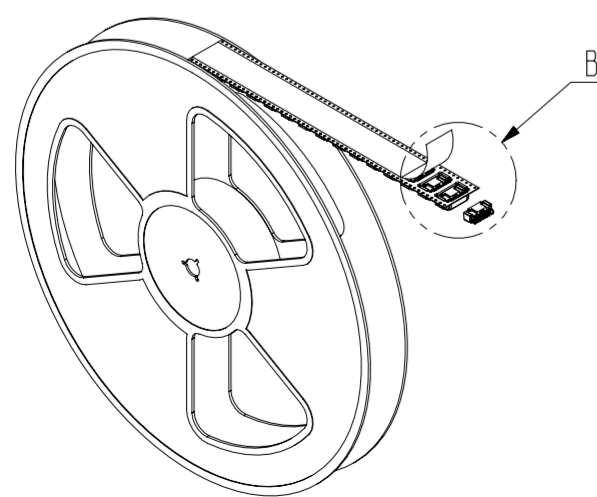

(SCALE 1:5)

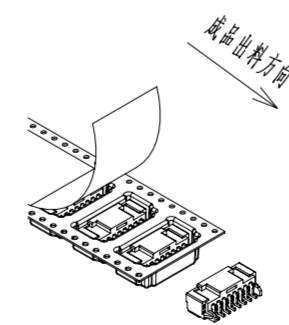

DETAIL B
SCALE 1:2

零件总成号	零件总成名称	颜色	A(mm)	B(mm)	适配零件号	N(数量)
XP0002145	0.5_PINH_15_NC	本色	34.0	11.8	-	15
XP0002144	0.5_PINH_14_NC	本色	32.0	11.8	-	14
XP0002143	0.5_PINH_13_NC	本色	30.0	11.8	-	13
XP0002142	0.5_PINH_12_NC	本色	28.0	11.8	XP0002152	12
XP0002141	0.5_PINH_11_NC	本色	26.0	11.8	XP0002151	11
XP0002140	0.5_PINH_10_NC	本色	24.0	11.8	XP0002150	10
XP0002139	0.5_PINH_9_NC	本色	22.0	11.8	XP0002149	9
XP0002138	0.5_PINH_8_NC	本色	20.0	11.8	XP0002148	8
XP0002137	0.5_PINH_7_NC	本色	18.0	11.8	XP0002147	7
XP0002136	0.5_PINH_6_NC	本色	16.0	11.8	XP0002146	6
XP0002135	0.5_PINH_5_NC	本色	14.0	11.8	XP0002131	5
XP0002134	0.5_PINH_4_NC	本色	12.0	-	XP0002130	4
XP0002133	0.5_PINH_3_NC	本色	10.0	-	XP0002129	3
XP0002132	0.5_PINH_2_NC	本色	8.0	-	XP0002080	2

GENERAL TOLERANCES	SCALE	ANGLE PROJECTION	MATERIAL:	FINISH/SURFACE:	COLOR:	VOLUME CAD:	WEIGHT CAD:	
见表格	6:1		见表格	见表格	见表格	-	-	
MODEL FILE NAME: 见表格			TITLE: XP0.5 RIGHT ANGLE CONNECTOR					
DRW FILE NAME: DCG000096_1_XP0002132			DRAWING NUMBER - REV: DCG000096_1					
START TIME: 2023-02-23			CAD LOCATION: PROJECT FOLDER					
DRAWN: JZhang			謙鑫實業股份有限公司					
CHECKERS:								
APPROVERS:			PJN	22BB	SHEET	1	OF	2

REV	ZONE	DESCRIPTION	DATE	DESIGNER	CHECKER
1	-	初始发布	2023-02-23	JZhang	YZhong

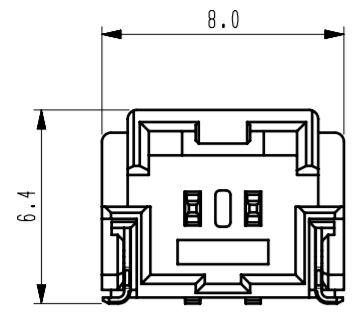

2P (XP0002132)

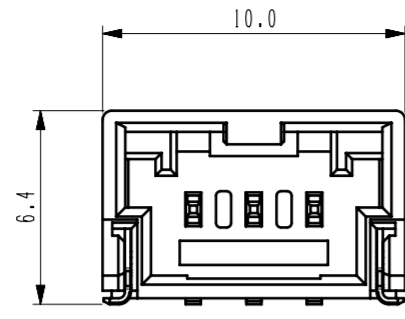

3P (XP0002133)

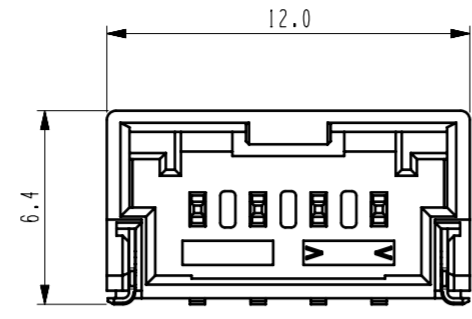

4P (XP0002134)

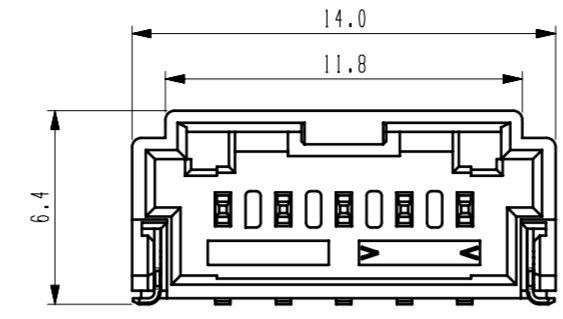

5P (XP0002135)

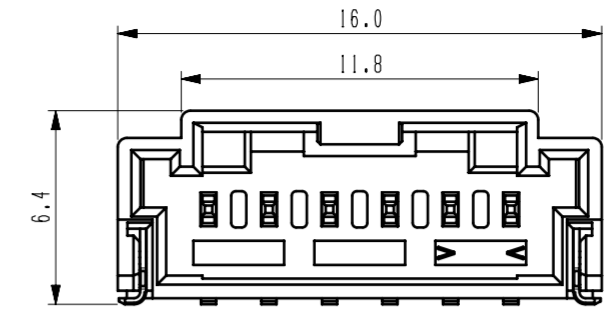

6P (XP0002136)

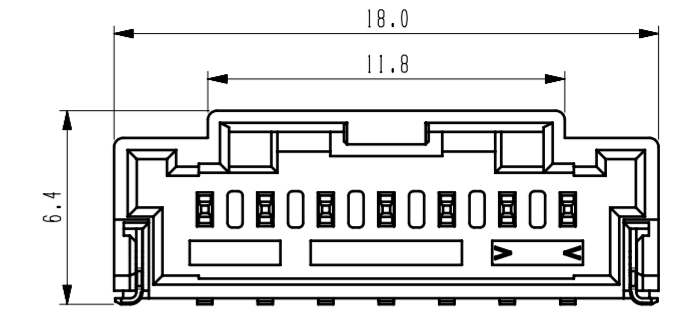

7P (XP0002137)

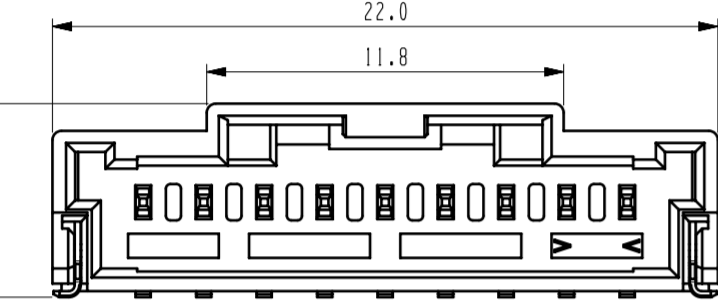
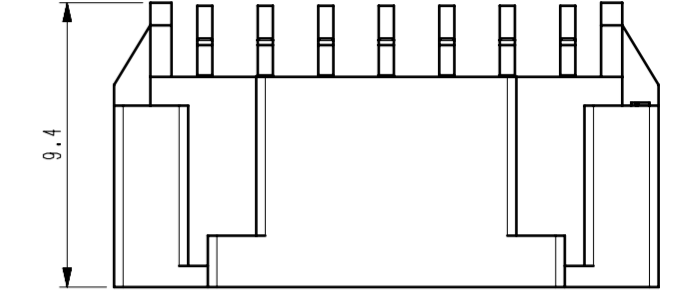
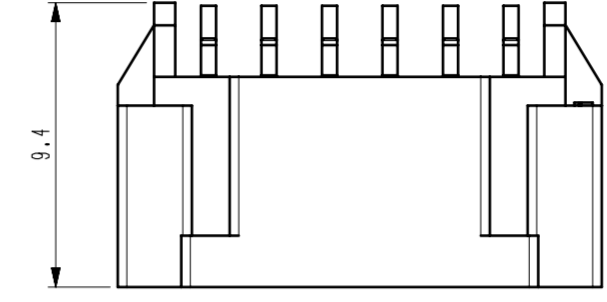
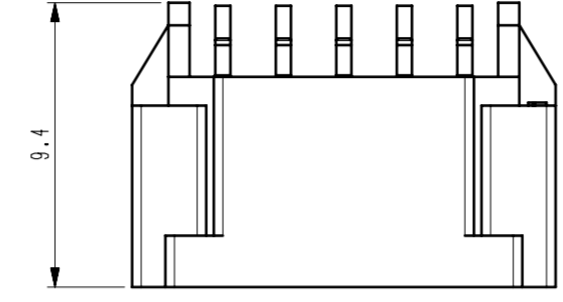
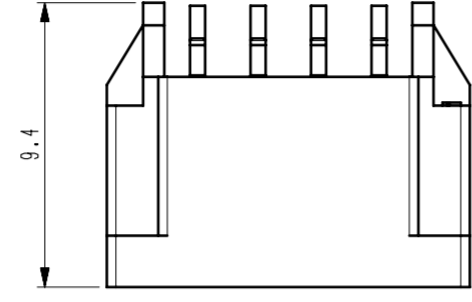
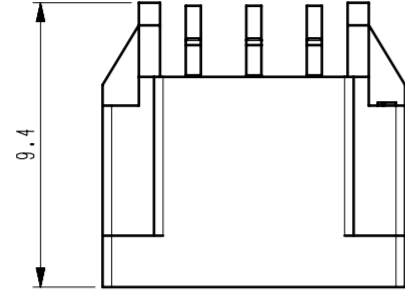
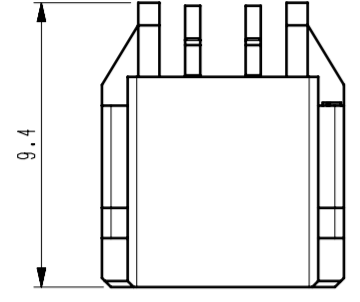

9P (XP0002139)

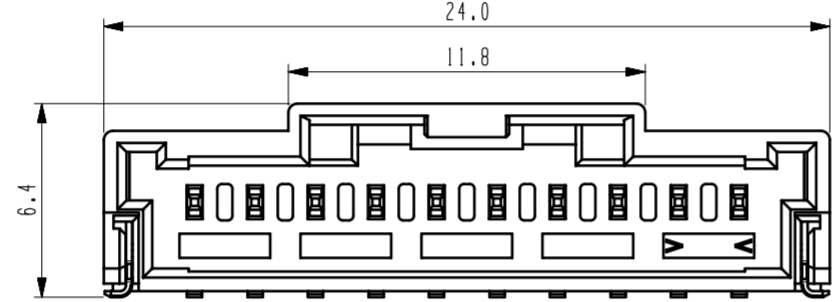

10P (XP0002140)

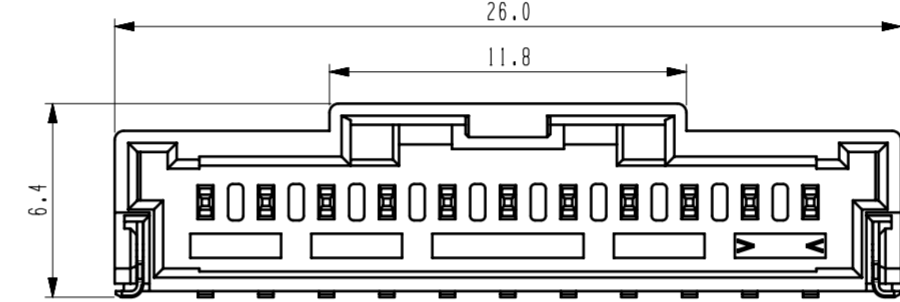

11P (XP0002141)

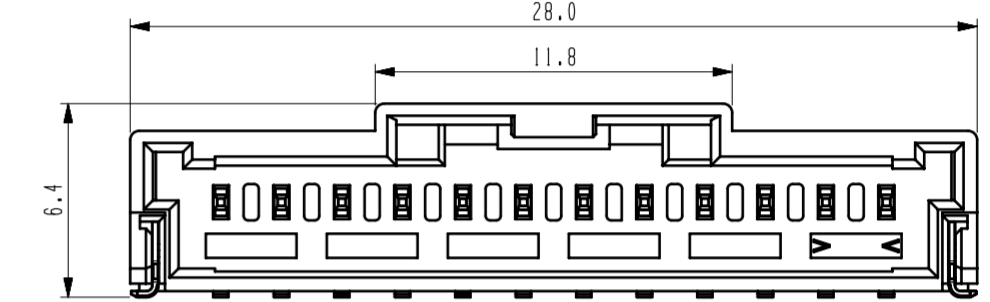

12P (XP0002142)

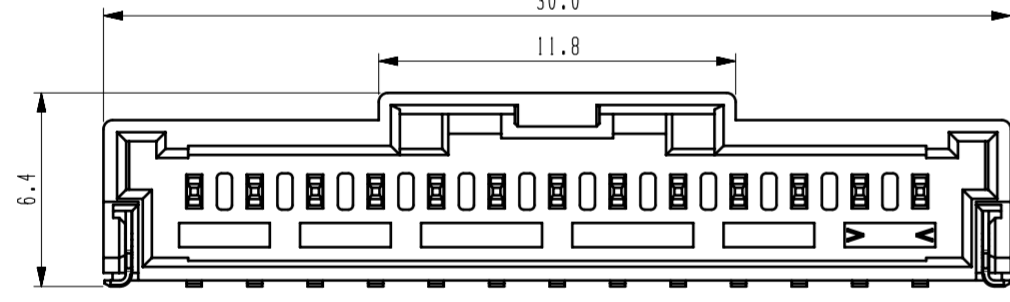
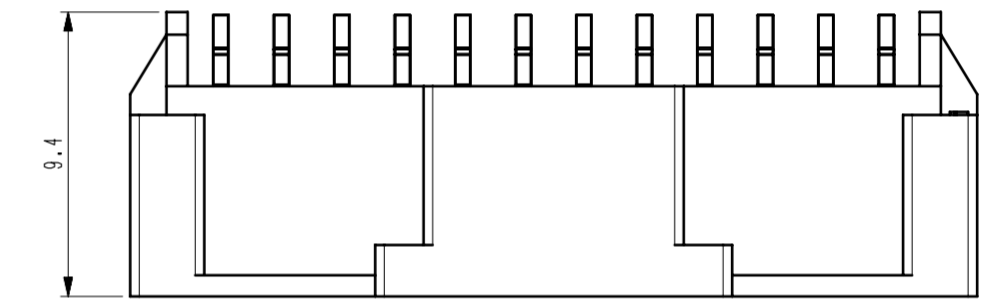
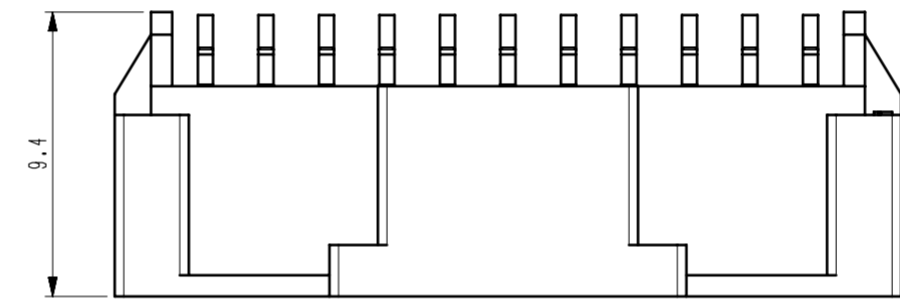
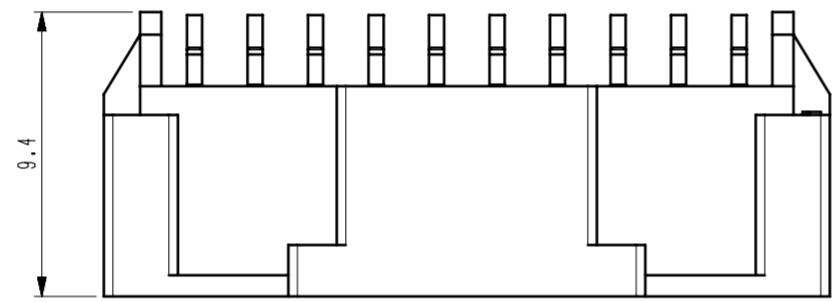
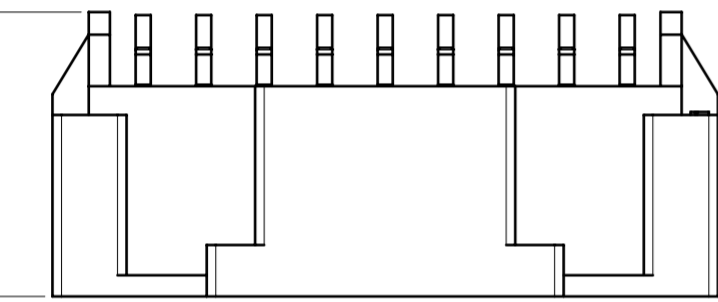

13P (XP0002143)

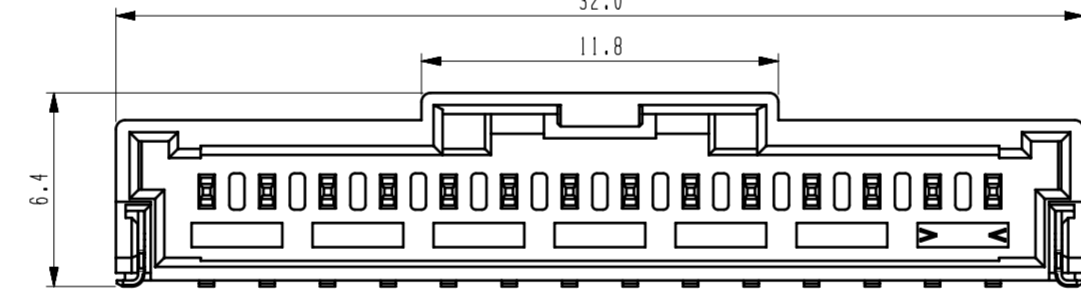

14P (XP0002144)

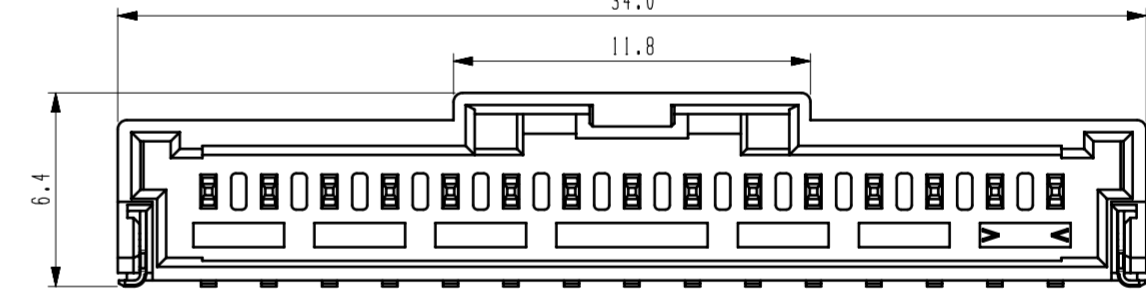

15P (XP0002145)

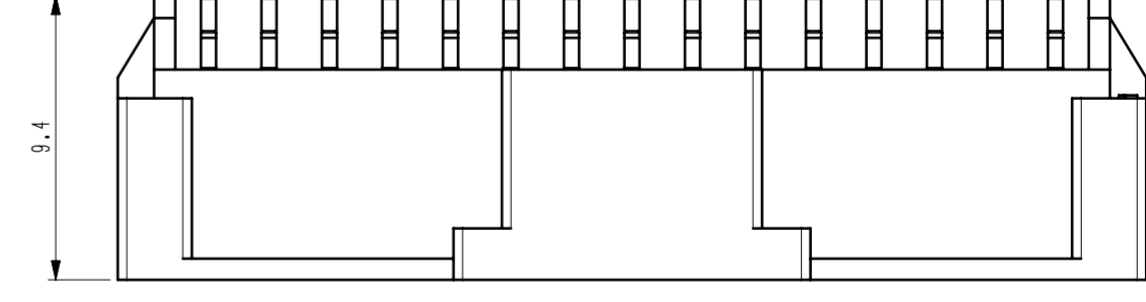
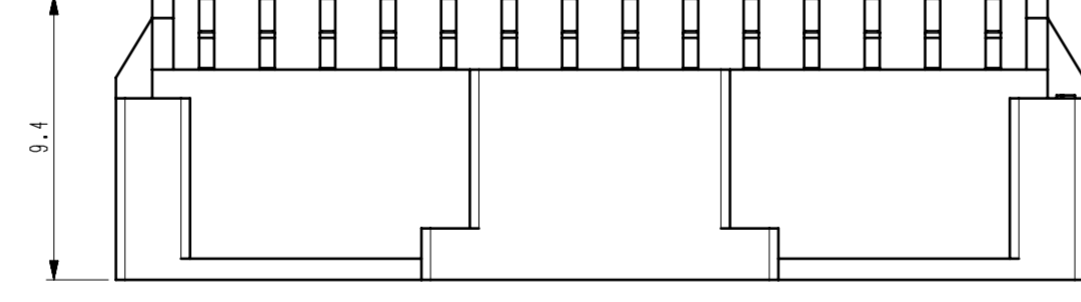
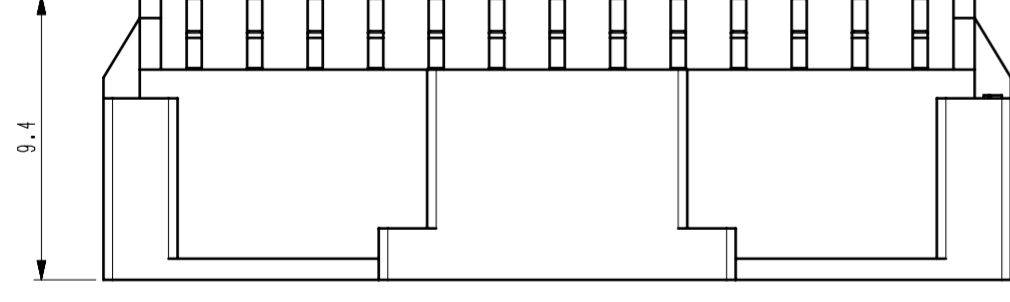

一般公差表	
≤10	± 0.20
>10≤30	± 0.25
>30	± 0.30
角度	+ 3°

GENERAL TOLERANCES 見表格	SCALE 4:1	ANGLE PROJECTION 	MATERIAL: 見表格	VOLUME CAD: -
			FINISH/SURFACE: 見表格	WEIGHT CAD: -
			COLOR: 見表格	
MODEL FILE NAME: 見表格			TITLE: XP0.5 RIGHT ANGLE CONNECTOR	
DRW FILE NAME: DCG000096_1_XP0002132			DRAWING NUMBER - REV: DCG000096_1	
START TIME: 2023-02-23			CAD LOCATION: PROJECT FOLDER	
DRAWN: JZhang			謙鑫實業股份有限公司	
CHECKERS:				
APPROVERS:			PJN 22BB	SHEET 2 OF 2